

DF910

LAT PULLDOWN MACHINE

Assembly Manual

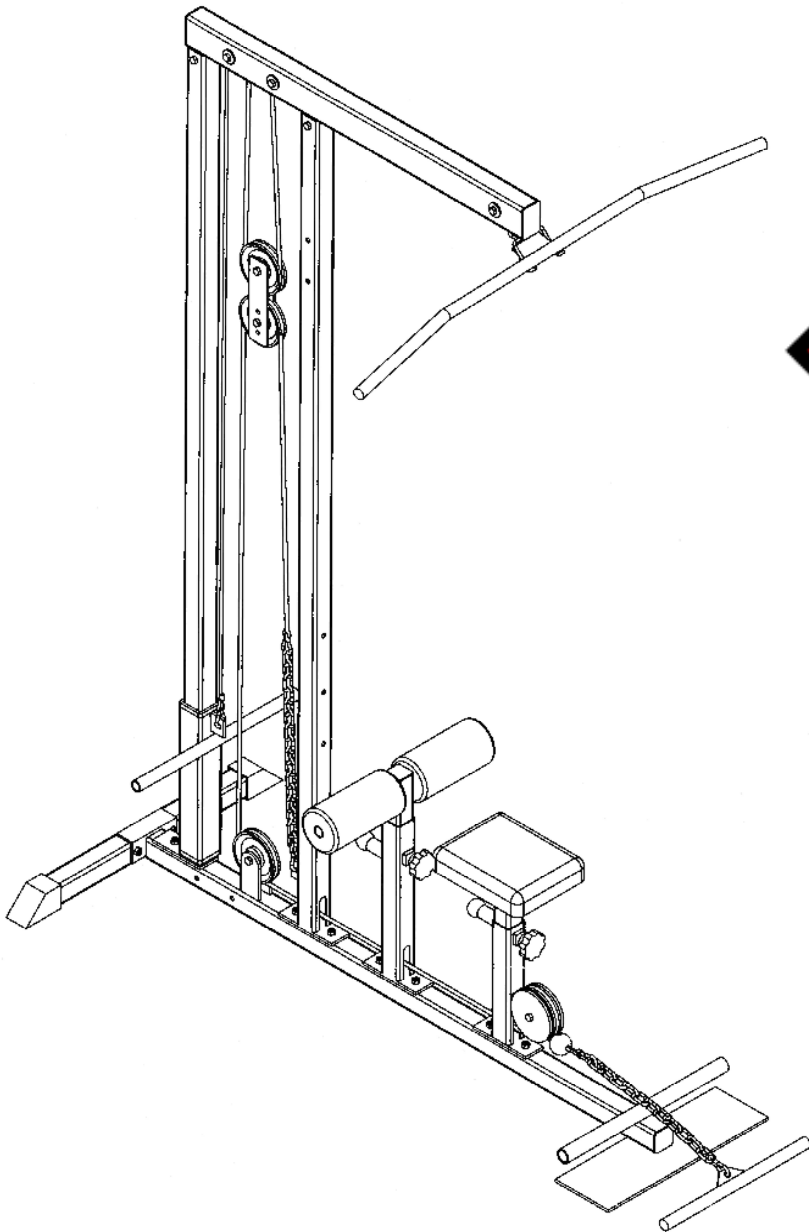

(888) 258-0533

FOR YOUR SAFETY READ ALL INSTRUCTIONS CAREFULLY

*NOTE IF YOU ARE MISSING HARDWARE OR HAVE ANY FIT UP PROBLEMS PLEASE CONTACT DELTECH FITNESS TOLL FREE (888) 258-0533

BOX CONTENTS



A

**REAR SUPPORT
QTY 1**

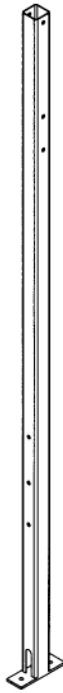

B

**FRONT SUPPORT
QTY 1**

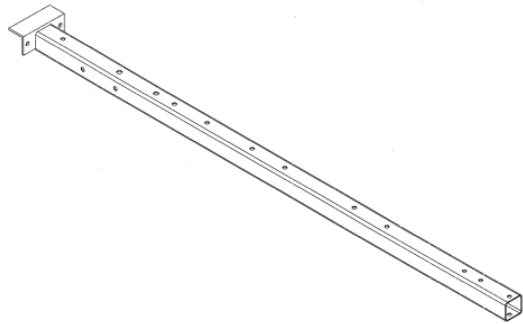

C

**BOTTOM FRAME
QTY 1**

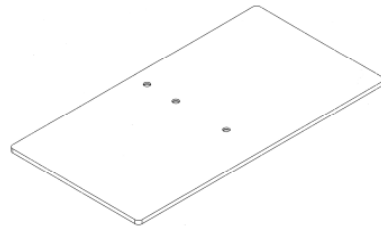

C1

**FOOT PLATE
QTY 1**

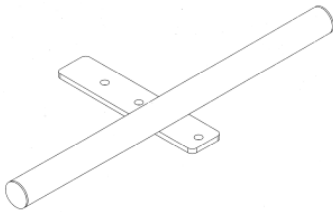

C2

**FOOT REST
QTY 1**

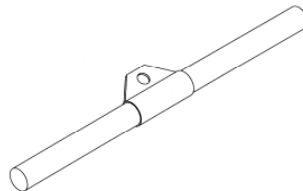

D

**REVOLVING CHROME
ROW BAR
QTY 1**

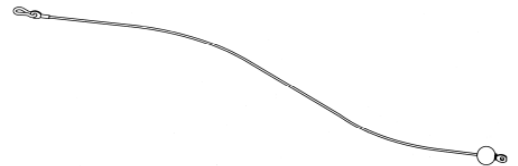

E

**LAT CABLE
QTY 2**

*NOTE IF YOU ARE MISSING HARDWARE OR HAVE ANY FIT UP PROBLEMS PLEASE CONTACT DELTECH FITNESS TOLL FREE (888) 258-0533

BOX CONTENTS

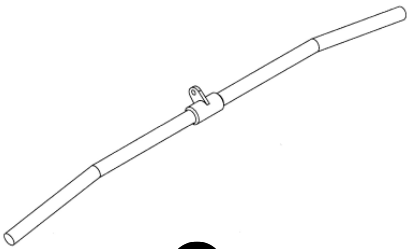

F
LAT BAR
QTY 1

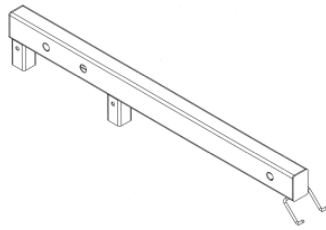

G
UPPER PULLEY
FRAME
QTY 1

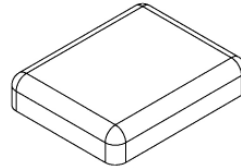

H
SEAT PAD
QTY 1

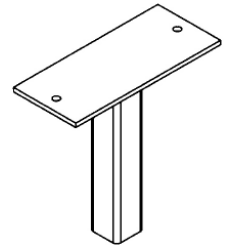

I
SEAT BRACKET
QTY 1

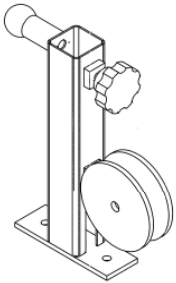

J
SEAT SUPPORT
QTY 1

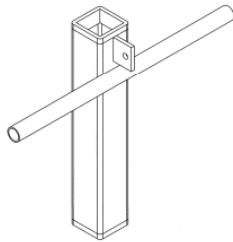

K
WEIGHT SLIDE
QTY 1

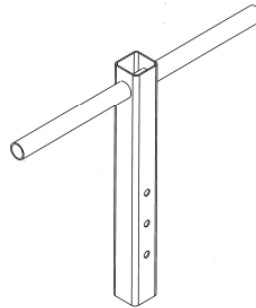

L
HOLD-DOWN
TUBE

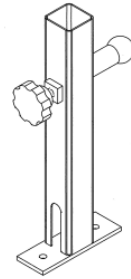

M
HOLD-DOWN SUPPORT
QTY 1

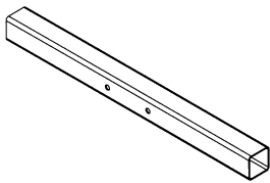

N
REAR CROSSMEMBER
QTY 1

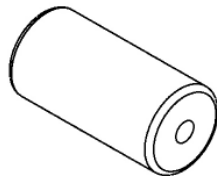

P
ROLLER PAD
QTY 2

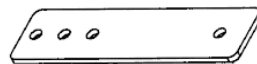

Q
FLANGE
QTY 2

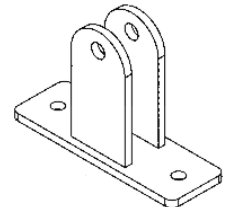

R
BOTTOM PULLEY
FRAME
QTY 1

*NOTE IF YOU ARE MISSING HARDWARE OR HAVE ANY FIT UP PROBLEMS PLEASE CONTACT DELTECH FITNESS TOLL FREE (888) 258-0533

HARDWARE



S

**MUSHROOM CAP
QTY 2**

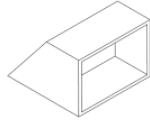

T

**RUBBER SHOE
QTY 2**



U

**4-1/2" PULLEY
QTY 3**



V

**3-1/2" PULLEY
QTY 4**



W

**PULLEY BUSHING
QTY 6**



X

**SNAP HOOK
QTY 6**



Y

**CHAIN
QTY 2**

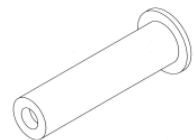

Z

**OLYMPIC ADAPTER
QTY 2**

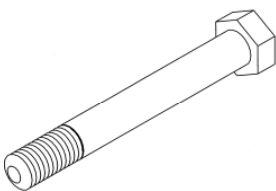

AA

**M12 x 70MM BOLT
QTY 2**

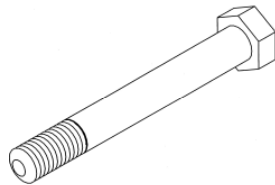

BB

**M12 x 65MM BOLT
QTY 2**

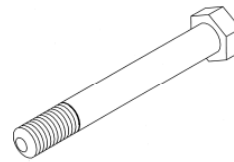

CC

**M10 x 70MM BOLT
QTY 3**

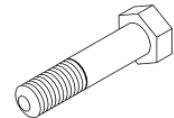

DD

**M10 x 45MM BOLT
QTY 4**

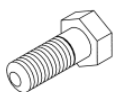

EE

**M10 x 20MM BOLT
QTY 2**

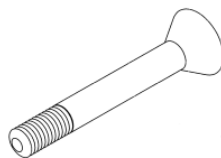

FF

**M10 x 70MM
FLAT HEAD BOLT
QTY 3**

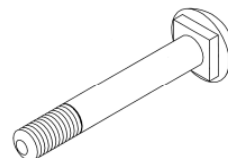

GG

**M10 x 65MM
CARRIAGE BOLT
QTY 9**

(888) 258-0533

FOR YOUR SAFETY READ ALL INSTRUCTIONS CAREFULLY

*NOTE IF YOU ARE MISSING HARDWARE OR HAVE ANY FIT UP PROBLEMS PLEASE CONTACT DELTECH FITNESS TOLL FREE (888) 258-0533

HARDWARE



HH

**M12 WASHER
QTY 8**



II

**M10 WASHER
QTY 20**



JJ

**M12 LOCKNUT
QTY 4**



KK

**M10 LOCKNUT
QTY 19**

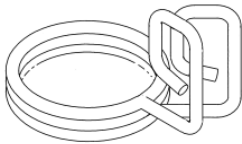

LL

**OLYMPIC COLLAR
QTY 2**



MM

**STANDARD COLLAR
QTY 2**

BOTTOM FRAME ASSEMBLY

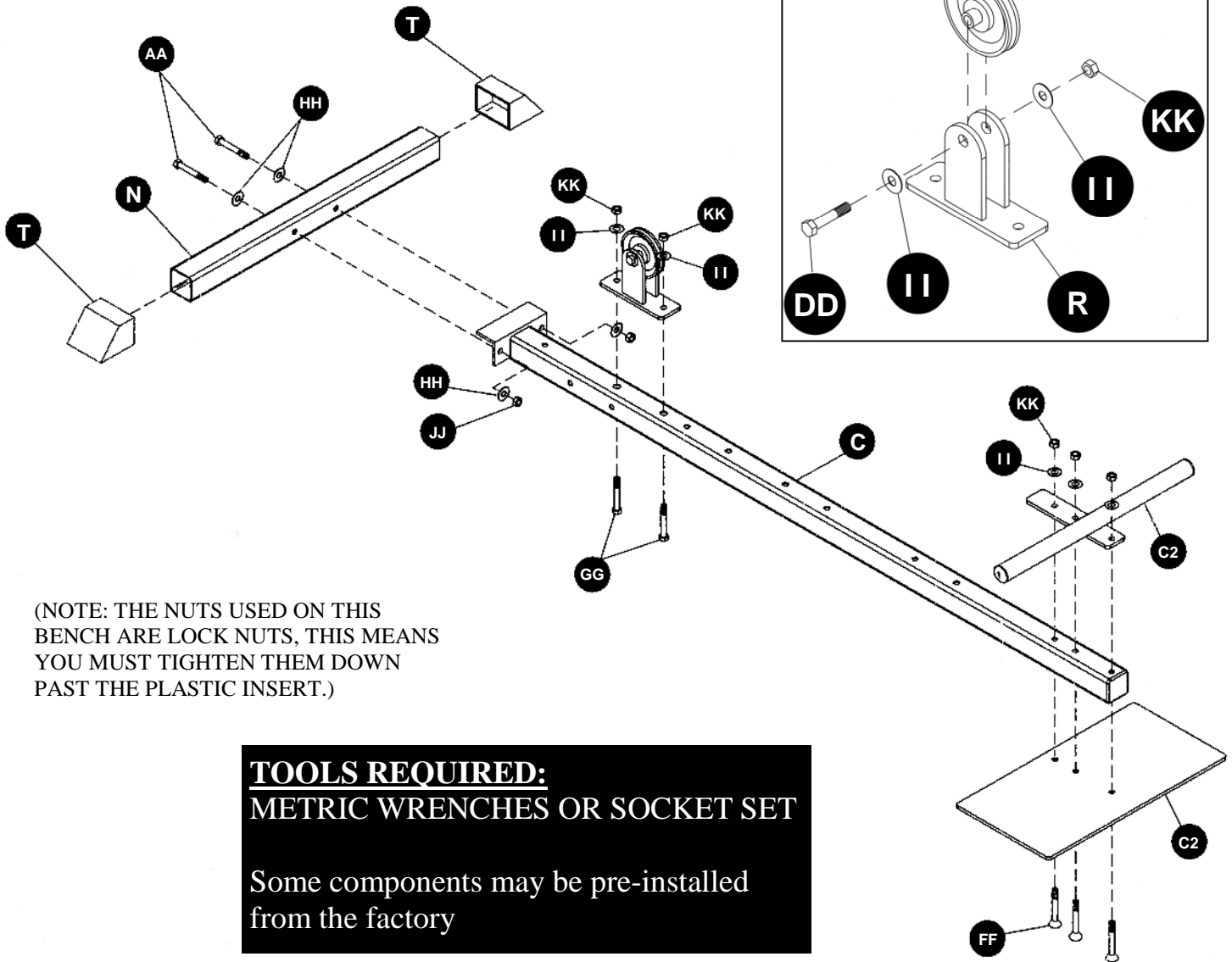

(NOTE: THE NUTS USED ON THIS BENCH ARE LOCK NUTS, THIS MEANS YOU MUST TIGHTEN THEM DOWN PAST THE PLASTIC INSERT.)

TOOLS REQUIRED: METRIC WRENCHES OR SOCKET SET

Some components may be pre-installed from the factory

(SEE INSET) ASSEMBLE THE 4 ½" PULLEY (U) INTO THE BOTTOM PULLEY FRAME (R) USING THE M10 x 45MM BOLT (DD), M10 WASHERS (II), AND M10 LOCKNUT (KK).

INSTALL TO BOTTOM FRAME (C) USING THE M10 x 65MM CARRIAGE BOLTS (GG), M10 WASHERS (II), AND M10 LOCKNUTS (KK).

ATTACH THE REAR CROSSMEMBER (N) TO THE BOTTOM FRAME (C) USING THE M12 x 70MM BOLTS (AA), M12 WASHERS (HH), AND M12 LOCKNUTS (JJ). INSTALL THE RUBBER BOOTS (T) OVER THE ENDS OF THE CROSSMEMBER.

ATTACH THE FOOT PLATE (C2) AND FOOT REST (C1) TO THE BOTTOM FRAME (C) USING M10 x 70 MM FLAT HEAD BOLTS (FF), M10 WASHERS (II), AND M10 LOCKNUTS (KK).

SEAT FRAME ASSEMBLY

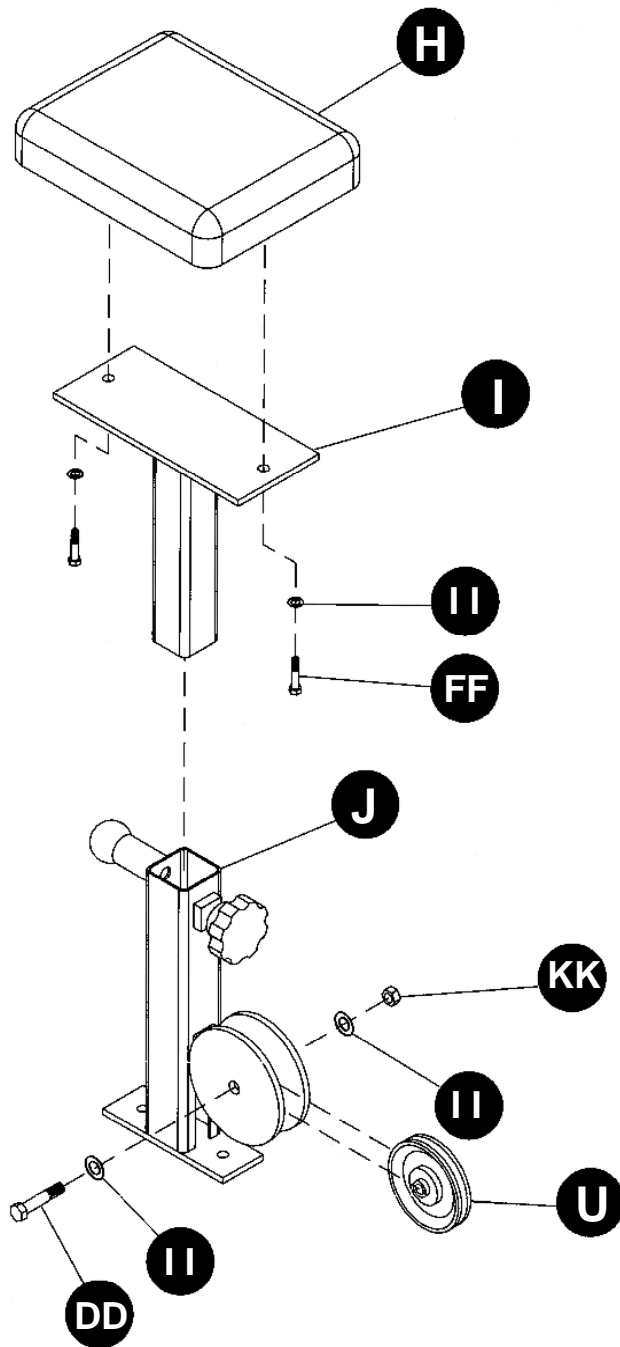

ATTACH THE SEAT PAD (**H**) TO THE SEAT BRACKET (**I**) USING THE M10 x 20MM BOLTS (**EE**) AND M10 FLAT WASHERS (**II**). THEN SLIDE THE SEAT BRACKET (**I**) INTO THE SEAT SUPPORT (**J**).

(WAIT TO COMPLETE THE FOLLOWING STEP UNTIL THE CABLES ARE INSTALLED)

INSTALL THE 4 ½" PULLEY (**U**) INTO THE SEAT SUPPORT TUBE (**J**) USING THE M10 x 45MM BOLT (**DD**), M10 WASHERS (**II**), AND M10 LOCK NUT (**KK**).

LEG HOLD DOWN ASSEMBLY

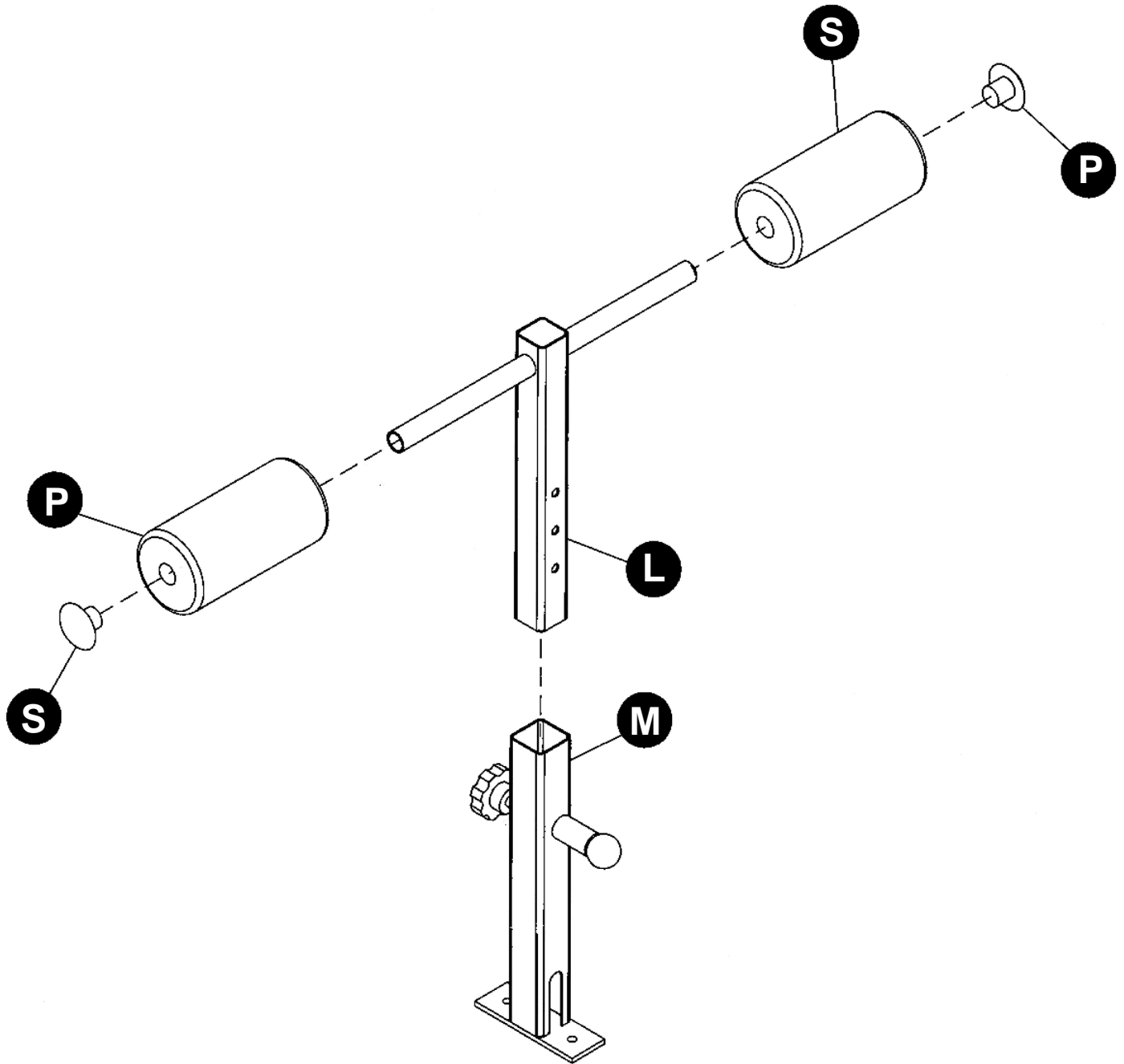

SLIDE THE HOLD-DOWN TUBE (L) INTO THE HOLD-DOWN SUPPORT (M) . LOCK INTO PLACE WITH PULL-PIN.

SLIDE THE ROLLER PADS (P) OVER THE LEG PAD TUBE AND INSERT THE MUSHROOM CAPS (S). TAP INTO PLACE WITH A RUBBER HAMMER.

FLOATING PULLEY ASSEMBLY

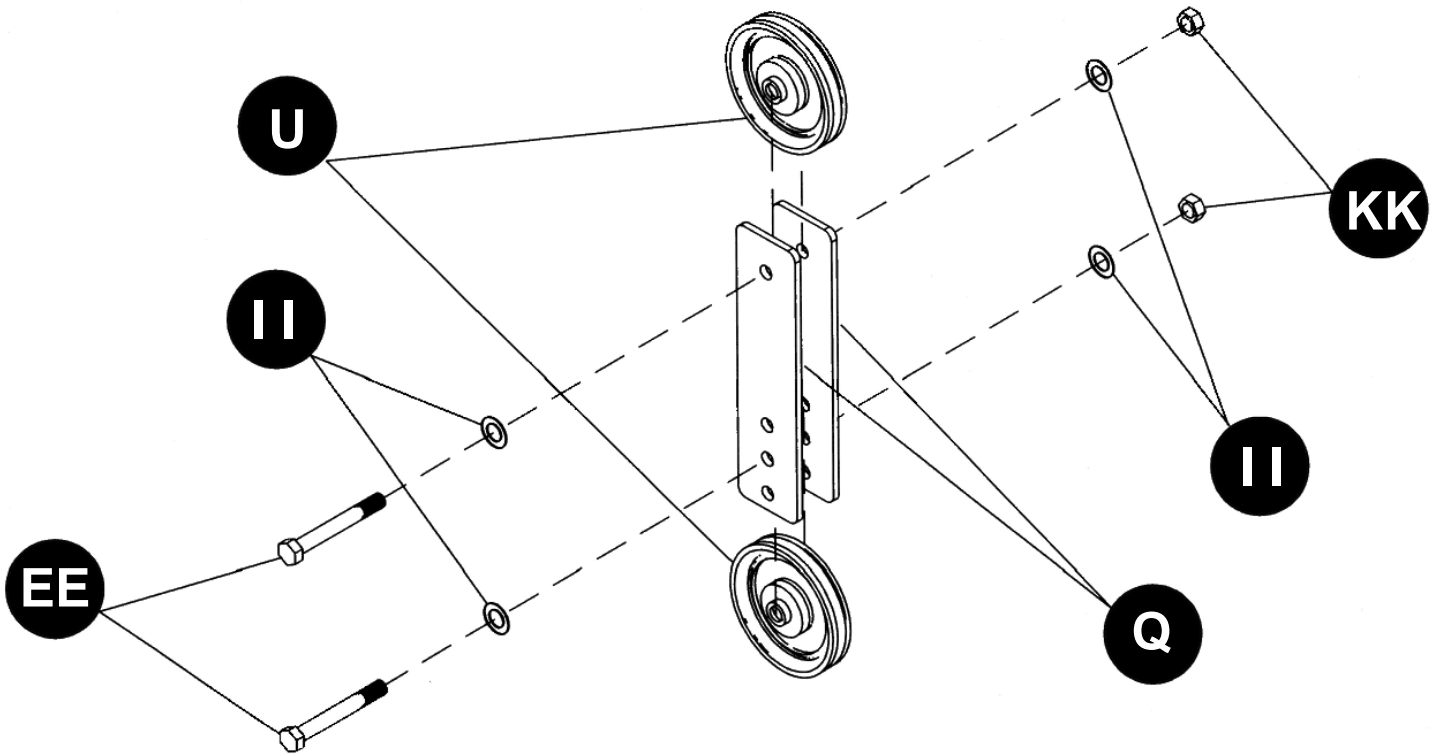

ASSEMBLE THE FLOATING PULLEY ASSEMBLY BY USING 4-1/2" PULLEYS (U), FLANGES (Q), M10 x 45MM BOLTS (DD), M10 WASHERS (II), AND M10 LOCKNUTS (KK).

UPPER PULLEY FRAME ASSEMBLY

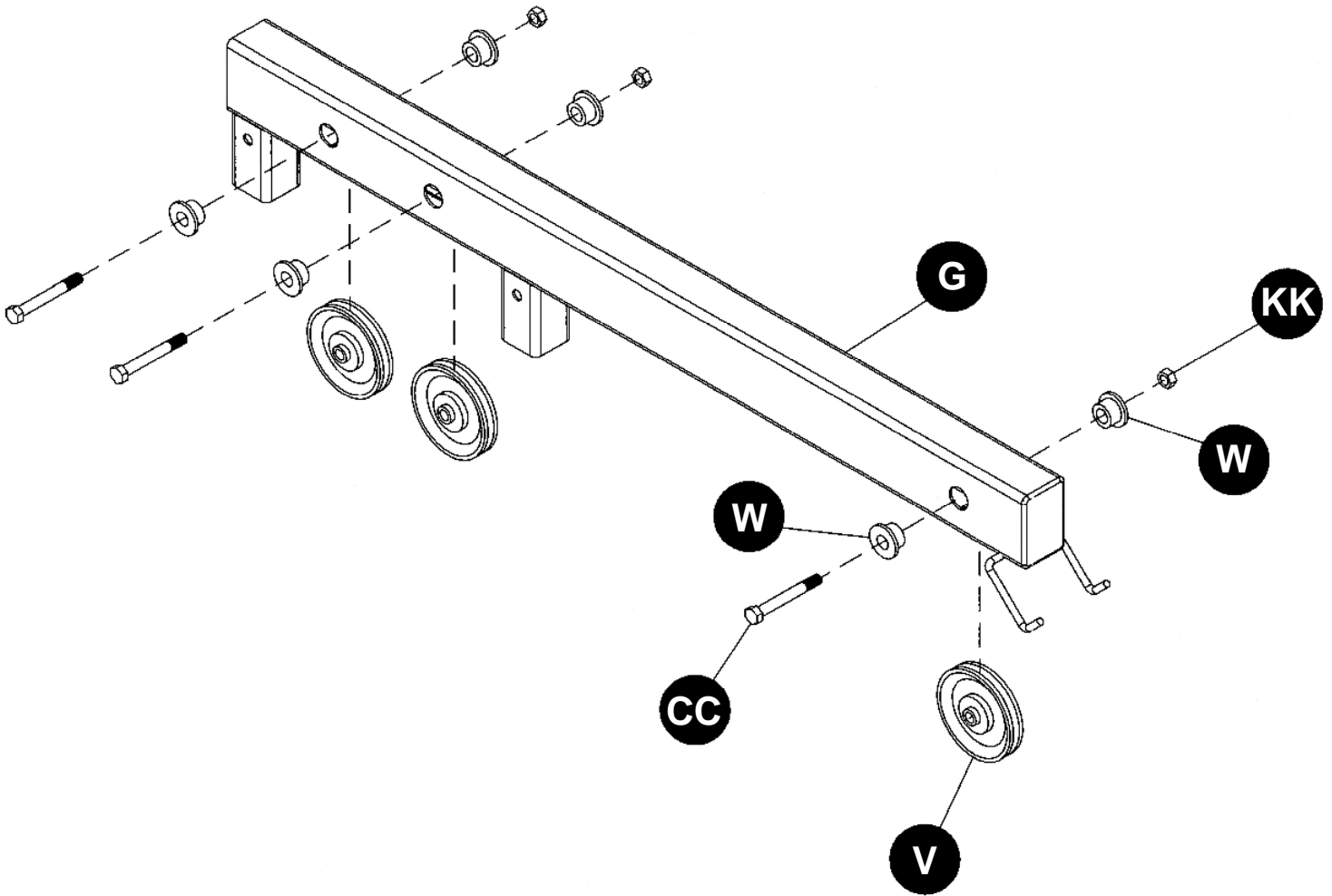

INSTALL THE FRONT 3-1/2" PULLEY (V) USING THE M10 x 70MM BOLT (CC), PULLEY BUSHINGS (W), AND M10 LOCKNUT (KK). REPEAT FOR REAR PULLEYS.

MAIN FRAME ASSEMBLY

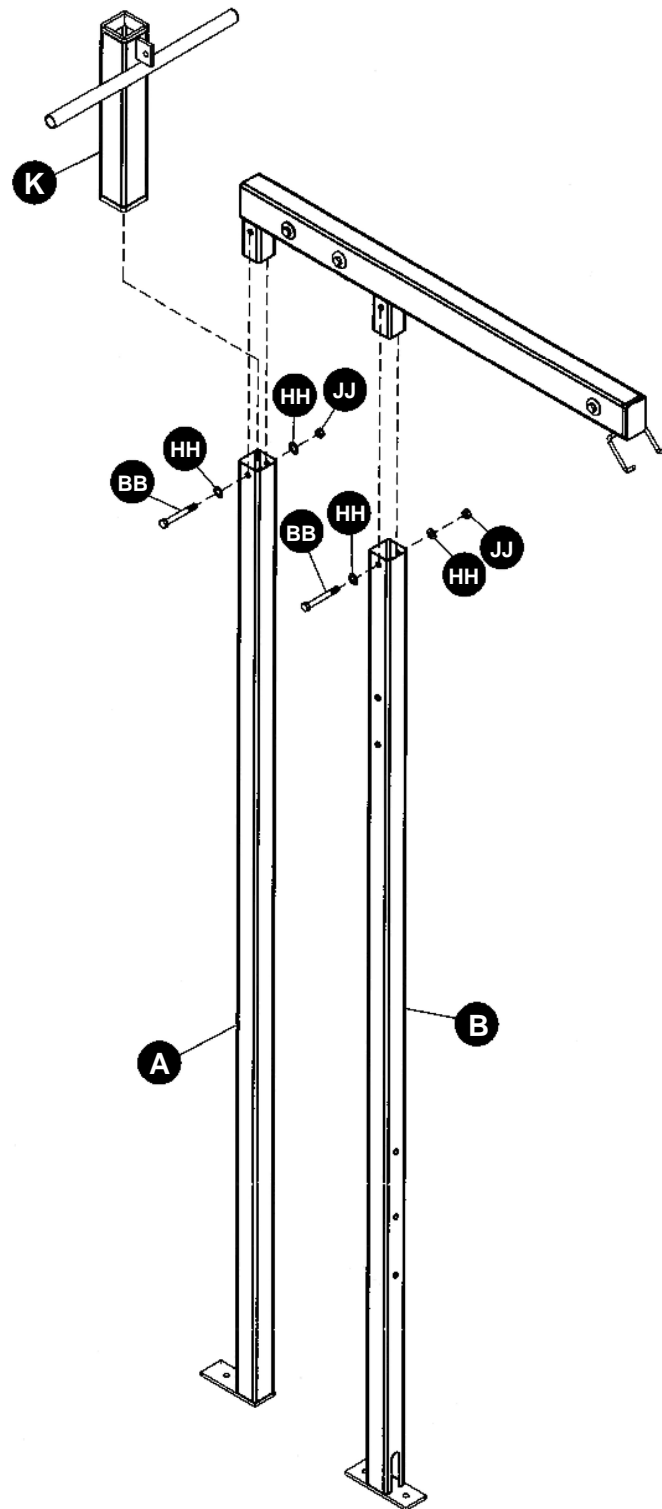

INSTALL THE WEIGHT SLIDE ASSEMBLY ONTO THE BACK SUPPORT (A)

NEXT ASSEMBLE THE UPPER PULLEY FRAME ASSEMBLY ONTO THE FRONT AND BACK SUPPORTS (A,B) USING THE M12 x 65MM BOLTS(BB), M12 WASHERS (HH), AND M12 LOCKNUTS (JJ).

FINAL ASSEMBLY

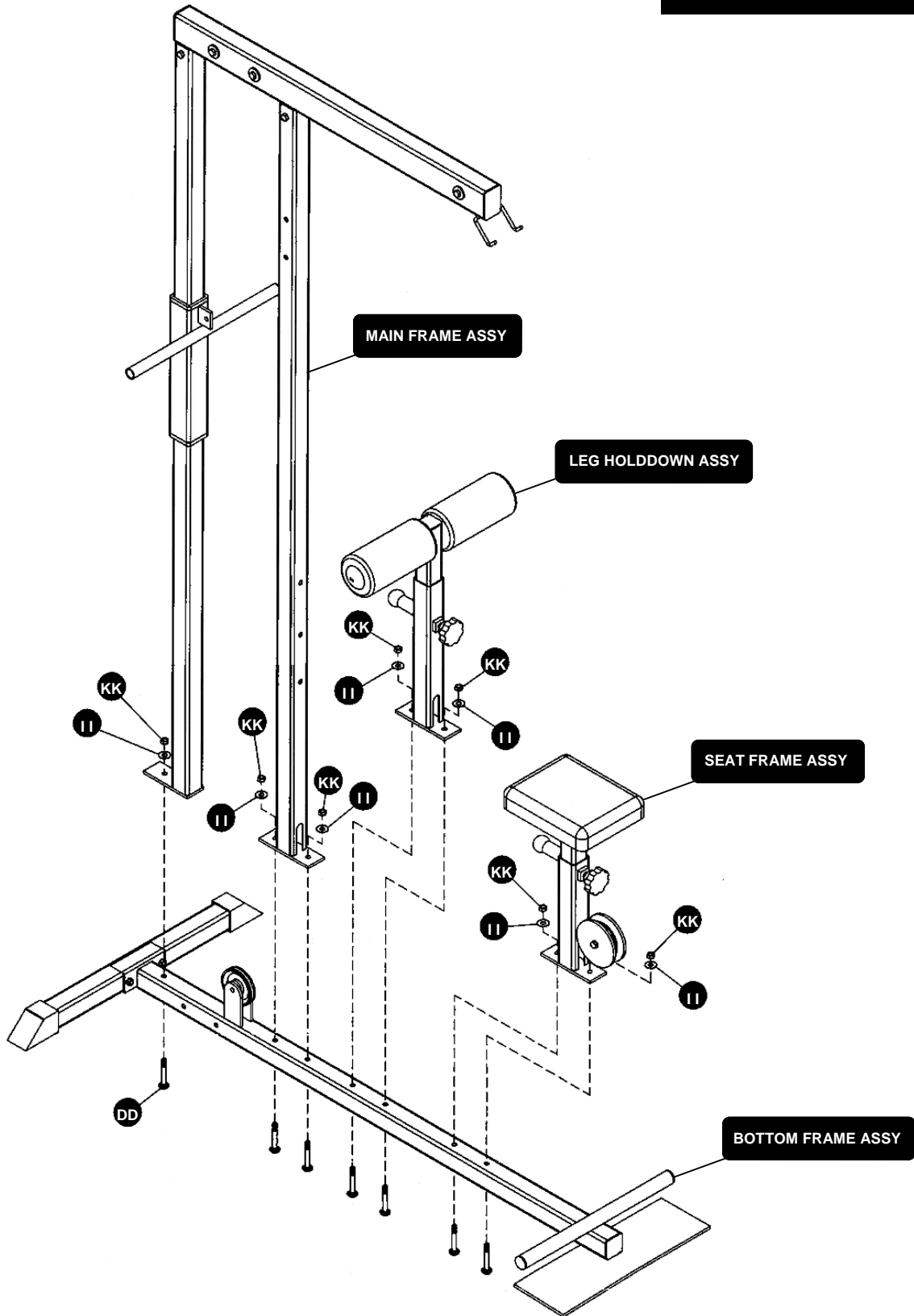

LAY THE BOTTOM FRAME ASSEMBLY ON ITS SIDE. ATTACH THE MAIN FRAME ASSEMBLY, THE LEG HOLDDOWN ASSEMBLY, AND THE SEAT FRAME ASSEMBLY USING THE M10 x 65MM CARRIAGE BOLTS (GG), M10 WASHERS (II), AND M10 LOCKNUTS (KK).

CABLE INSTALLATION

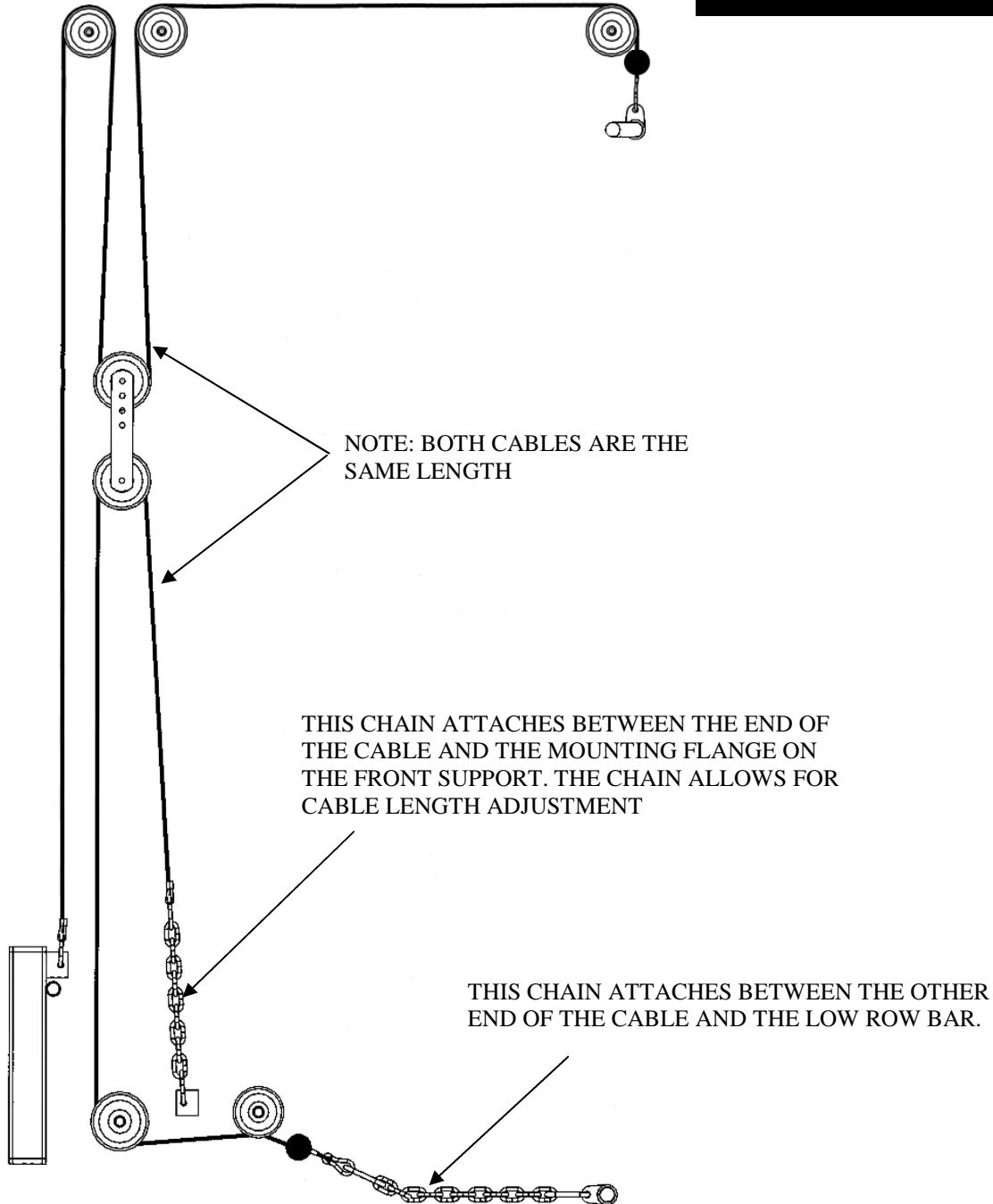

STARTING WITH THE CABLE END WITHOUT THE BALL, INSTALL UPPER CABLE OVER FRONT PULLEY, BACK TO MIDDLE PULLEY, DOWN TO TOP PULLEY OF FLOATING PULLEY ASSEMBLY, UP TO REAR PULLEY AND DOWN TO WEIGHT CARRIAGE. ATTACH SNAP HOOK TO END OF CABLE AND THEN TO WEIGHT CARRIAGE BRACKET. ATTACH SNAP HOOK TO BALL END OF CABLE AND ATTACH LAT BAR.



















STARTING WITH THE CABLE END WITHOUT THE BALL, INSTALL LOWER CABLE UNDER FRONT PULLEY, BACK TO REAR PULLEY AND UP AND OVER LOWER PULLEY OF FLOATING PULLEY ASSEMBLY. ATTACH SNAP HOOK TO END OF CABLE AND THEN TO ONE END OF THE CHAIN. ATTACH SNAP HOOK TO THE OTHER END OF CHAIN AND THEN TO MOUNTING FLANGE ON FRONT SUPPORT TUBE. ATTACH SNAP HOOK TO BALL END OF CABLE AND ATTACH 10" CHAIN. ATTACH SNAP HOOK AND ROW BAR.

SAFETY NOTICE

WARNING: THE USER OF THIS WEIGHT EQUIPMENT ASSUMES THE POSSIBILITY OF INJURY BY EXERCISING ON THIS EQUIPMENT. THE POSSIBILITY OF RISK CAN BE REDUCED BY ALWAYS FOLLOWING THESE SIMPLE RULES:

- 1) BEFORE BEGINNING ANY EXERCISE PROGRAM, CONSULT YOUR DOCTOR FOR A COMPLETE PHYSICAL EXAMINATION AND SUGGESTED EXERCISE PROGRAM SPECIFIC FOR YOU.
- 2) STRETCH BEFORE AND AFTER THE EXERCISE PROGRAM. PROPER STRETCHING WILL PREPARE YOUR JOINTS AND MUSCLES FOR EXERCISE AND HELP AVOID INJURIES.
- 3) IF AT ANY TIME YOU SHOULD FEEL FAINT OR DIZZY, NAUSEOUS OR EXPERIENCE ANY OTHER ABNORMAL SYMPTOMS OR DISCOMFORT DISCONTINUE USE AND CONSULT YOUR DOCTOR.
- 4) DO NOT USE THIS EQUIPMENT WITHOUT QUALIFIED SUPERVISION AND PROPER TRAINING. NEVER WORK OUT ALONE- ALWAYS HAVE A PARTNER.
- 5) SECURELY TIGHTEN ALL BOLTS AND REGULARLY CHECK TO ENSURE ALL BOLTS HAVE NOT LOOSENED.
- 6) WEAR GOOD RUBBER SOLE SHOES ONLY. DO NOT USE BARE FOOTED OR WITH SOCKS ONLY.
- 7) DO NOT WEAR LOOSE CLOTHES SUCH AS ROBES, GOWNS, PANTS, LONG SHIRTS OR JEWELRY WHICH COULD BECOME ENTANGLED IN MOVING PARTS.
- 8) DO NOT STAND OR KNEEL ON SEAT. ALWAYS SIT OR LAY SQUARELY CENTERED.
- 9) KEEP HEAD, LIMBS AND BODY PARTS CLEAR OF MOVING PARTS AND WEIGHT PLATES.
- 10) CHILDREN SHOULD NOT USE EXERCISE EQUIPMENT WITHOUT SUPERVISION BECAUSE OF POSSIBILITY OF INJURY FROM IMPROPER USAGE. THIS EQUIPMENT IS INTENDED FOR HOME USE ONLY.
- 11) REPLACEMENT OF WORN OR DEFECTIVE PARTS MUST BE WITH FACTORY AUTHORIZED PARTS. IF OTHER THAN FACTORY AUTHORIZED PARTS OR ASSESSORS ARE USED ALL WARRANTIES AND LIABILITIES BECOME VOID.

Exercise Chart for the DF906

Lat Pull		Low Row		Curl	
					
Start	Finish	Start	Finish	Start	Finish
Rev Curl		Row		Tri Pull	
					
Start	Finish	Start	Finish	Start	Finish
Squat		Shrug		Side Row	
					
Start	Finish	Start	Finish	Start	Finish

NOT ALL EXERCISES ARE RECOMMENDED FOR EVERYONE PLEASE CONSULT A PHYSICIAN BEFORE STARTING ANY EXERCISE PROGRAM

